

Package Information

Tape and Reel and PCB Assembly Information

Tape and Reel Ordering Information

Power Integrations makes selected surface-mount parts available in tape and reel form for use with automatic pick-and-place equipment. Tape and reel specifications meet or exceed industry standard specification EIA-481.

Ordering Information

Parts available in tape and reel form can be ordered by placing a tape and reel ordering suffix after the base part number. The ordering suffix is TL.

Base Part #	Tape and Reel Suffix
TNY264G	-TL

Please contact the factory for other options. Minimum order size is 1 reel per line item, and all orders will be in multiples of full reel quantities. The quantity per reel for each package type is shown in Table 1. Power Integrations normal terms and conditions apply.

Electrical Specifications

Parts are subjected to the Power Integrations standard test flow, after which the parts are loaded into the tape cavities and sealed with a cover tape using standard anti-static handling procedures. The tape and cover are constructed of conductive modified polystyrene, providing a surface resistivity of $\leq 10^6 \Omega/\text{square}$. The reel is made of polystyrene with a topical anti-static coating, providing a surface resistivity of $\leq 10^{11} \Omega/\text{square}$.

Physical Specifications

Physical specifications of the tape, cover, and reel are governed by EIA-481. Physical dimensions of the tapes are given in Figure 2 and

Package	Tape		Reel DIA	Reel QTY
	Width (W)	Pitch (P)		
SOT-23-6	8 mm	8 mm	330 mm	10000
SO-8* / SO-8C	12 mm	8 mm	330 mm	2500
SMD-8	16 mm	12 mm	330 mm	1000
SO-16B	16 mm	12 mm	330 mm	2500
HSOP-28	24 mm	12 mm	330 mm	1000
InSOP-24	24 mm	12 mm	330 mm	2000
TO-263	24 mm	16 mm	330 mm	750
eSOP-12B	24 mm	16 mm	330 mm	1000
eSOP-R16B	24 mm	16 mm	330 mm	1000
MinSOP-16A	24 mm	8 mm	330 mm	2000

Table 1. Primary Tape & Reel Dimensions and Reel Quantities. (*Identical to SOP8)

Table 2, and physical dimensions of the reels are given in Figure 3 and Table 3.

Packaging for Shipment

Power Integrations supplies the following information on the side of each reel for ease of product identification:

- Power Integrations part number (MPN), including orientation suffix
- Assembly date code (D/C)
- Assembly lot identification (LOT)
- Quantity (QTY)
- Tape and reel packing date code (R/D)

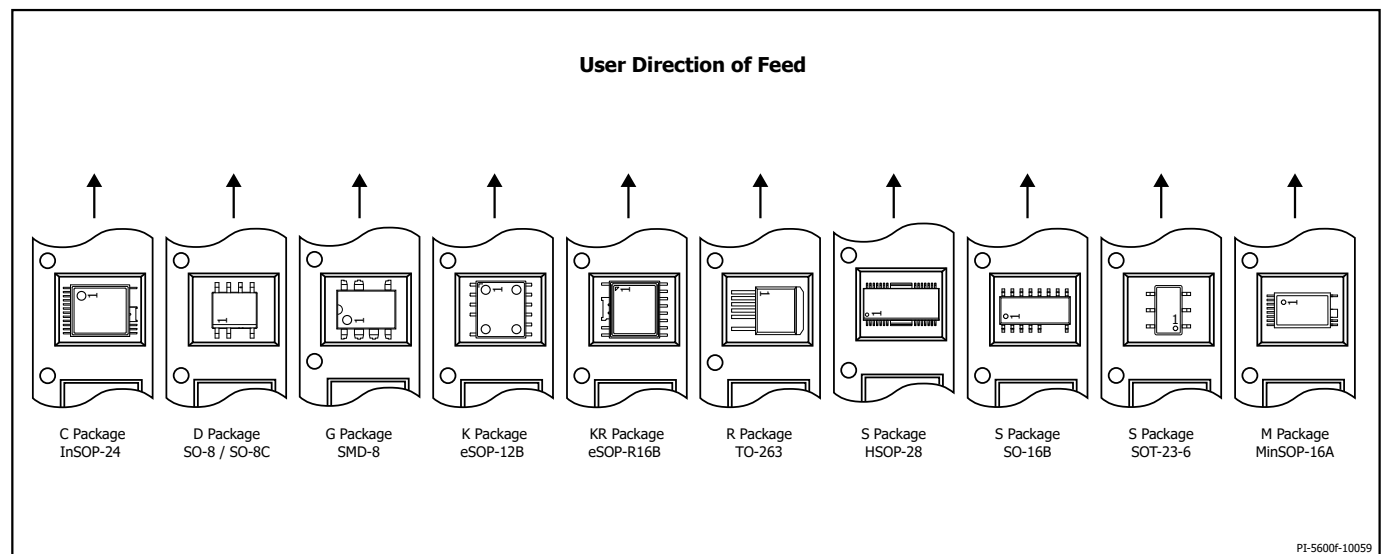
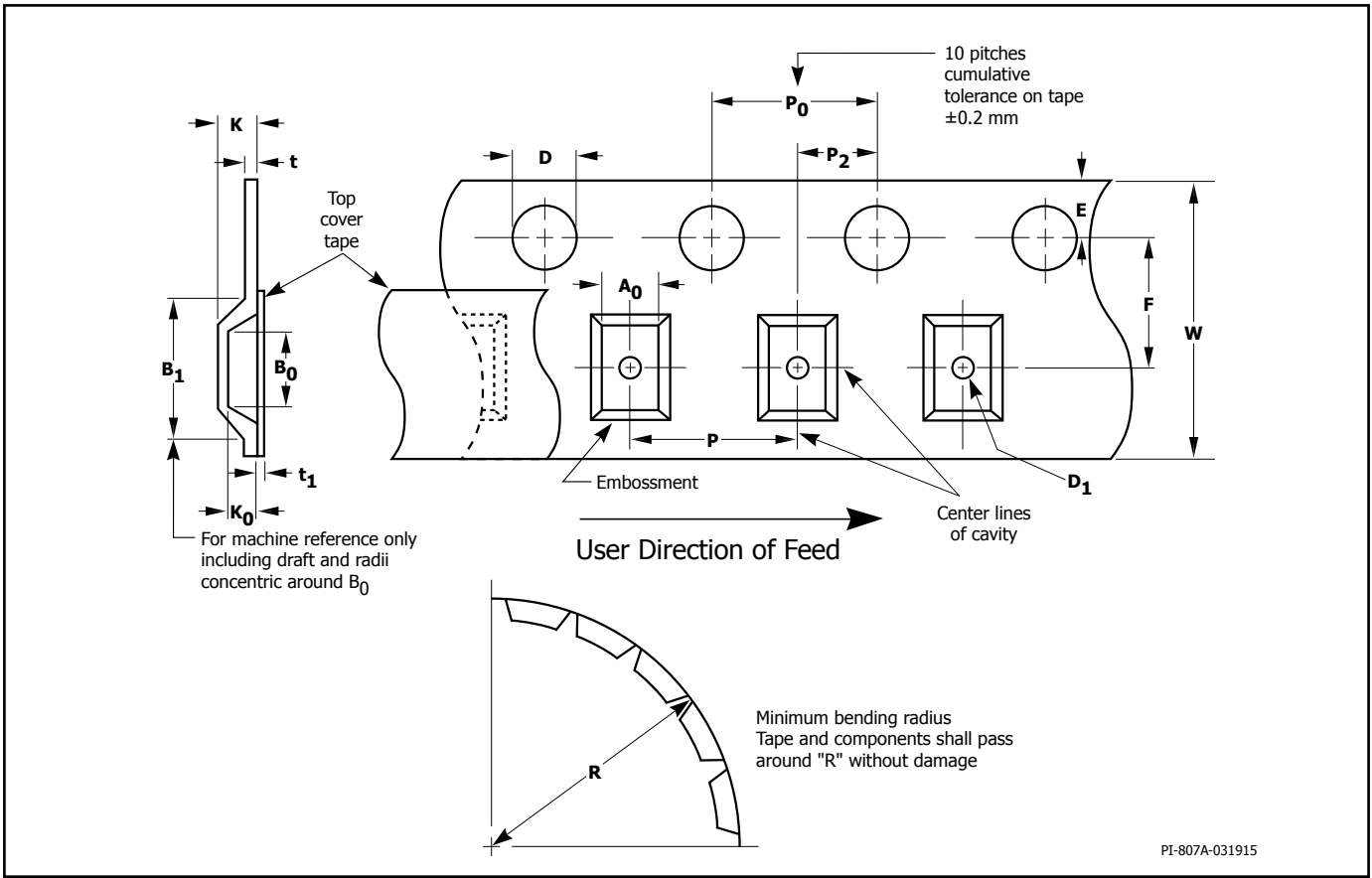

Figure 1. Part Orientation.

Package Information



PI-807A-031915

Figure 2. Tape Dimension Index.

Package Type	Tape Size	A ₀	B ₀	B ₁	D	D ₁	E	F	K
SOT-23-6	8 mm	5.20 - 5.40	3.30 - 3.50	N/A	1.5 - 1.6	1.5 - 1.7	1.65 - 1.85	5.40 - 5.60	N/A
SO-8 / SO-8C	12 mm	6.5 - 6.7	5.2 - 5.4	5.8 (max)	1.5 - 1.6	1.5 (min)	1.65 - 1.85	5.45 - 5.55	2.2 (max)
SO-16B	16 mm	6.5 - 6.8	10.3 - 10.6	12.3 (max)	1.5 - 1.6	1.5 (min)	1.65 - 1.85	7.40 - 7.60	2.4 (max)
SMD-8	16 mm	10.1 - 10.3	10.0 - 10.2	12.1 (max)	1.5 - 1.6	1.5 (min)	1.65 - 1.85	7.40 - 7.60	6.5 (max)
InSOP-24	24 mm	9.75 - 10.05	11.89 - 12.39	14.25 (max)	1.5 - 1.6	1.5 (min)	1.65 - 1.85	11.40 - 11.60	2.4 (max)
HSOP-28	24 mm	10.7 - 10.9	18.5 - 18.7	18.70 (max)	1.5 - 1.6	1.5 (min)	1.65 - 1.85	11.40 - 11.60	3.1 (max)
TO-263	24 mm	10.9 - 11.1	16.2 - 16.4	16.9 (max)	1.5 - 1.6	1.5 (min)	1.65 - 1.85	11.40 - 11.60	5.9 (max)
eSOP-12B	24 mm	10.27 - 10.77	11.89 - 12.39	13.25 (max)	1.5 - 1.6	1.4 (min)	1.65 - 1.85	11.40 - 11.60	3.22 (max)
eSOP-R16B	24 mm	10.27 - 10.77	11.89 - 12.39	13.25 (max)	1.5 - 1.6	1.4 (min)	1.65 - 1.85	11.40 - 11.60	3.22 (max)
MinSOP-16A	24 mm	6.0 - 6.20	11.70 - 11.90	12.00 (max)	1.5 - 1.6	1.5 (min)	1.65 - 1.85	11.40 - 11.60	2.20 (max)

Package Type	Tape Size	K ₀	P	P ₀	P ₂	R	t	t ₁	W
SOT-23-6	8 mm	1.30 - 1.50	7.9 - 8.1	3.9 - 4.1	1.90 - 2.10	EIA-481	0.25 - 0.35	N/A	11.7 - 12.3
SO-8 / SO-8C	12 mm	1.60 - 1.80	7.90 - 8.10	3.8 - 4.2	1.95 - 2.05	50 (min)	0.35 (max)	0.5 (typ)	11.7 - 12.3
SO-16B	16 mm	2.10 - 2.40	8.0 - 8.3	4.0 - 4.1	2.00 - 2.10	EIA-481	0.35 (max)	0.07 (max)	15.7 - 16.3
SMD-8	16 mm	3.60 - 3.80	11.9 - 12.1	3.9 - 4.1	1.90 - 2.10	40 (min)	0.400 (max)	0.10 (max)	15.7 - 16.3
InSOP-24	24 mm	1.95	12.00	3.9 - 4.1	3.9 - 4.1	Standard	0.35 (max)	0.35 (max)	23.90 - 24.30
HSOP-28	24 mm	3.04 - 3.06	12.00	3.8 - 4.2	1.90 - 2.10	Standard	0.35 (max)	.05 (max)	23.7 - 24.3
TO-263	24 mm	5.40 - 5.60	15.9 - 16.1	3.9 - 4.1	1.90 - 2.10	50 (min)	0.350 (max)	0.07 (max)	23.7 - 24.3
eSOP-12B	24 mm	2.72 - 3.22	15.9 - 16.1	3.9 - 4.1	1.90 - 2.10	EIA-481	0.385 (max)	0.7 (max)	23.7 - 24.3
eSOP-R16B	24 mm	2.72 - 3.22	15.9 - 16.1	3.9 - 4.1	3.9 - 4.1	Standard	0.385 (max)	0.7 (max)	23.7 - 24.3
MinSOP-16A	24 mm	2.50 - 2.70	8.0	3.9 - 4.1	1.90 - 2.10	Standard	0.35 (max)	0.7 (max)	23.90 - 24.30

Table 2. Tape Dimensions (in mm).

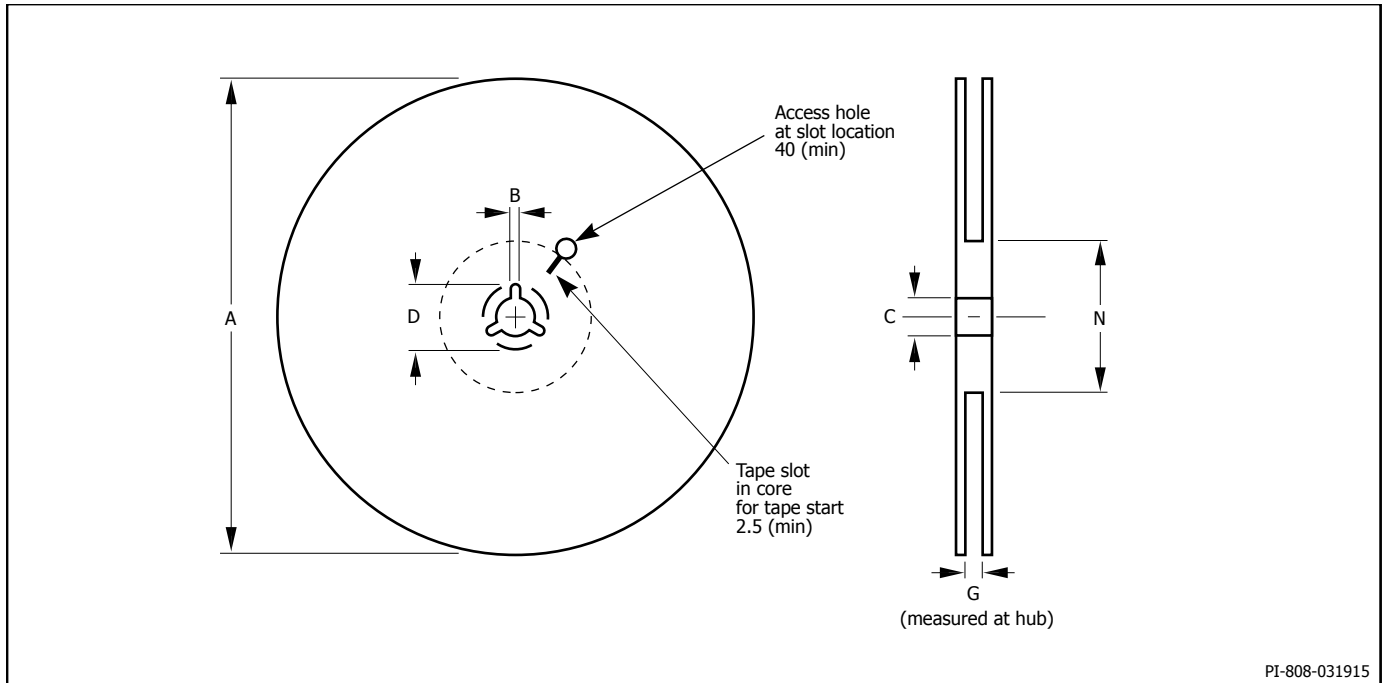

PI-808-031915

Figure 3. Reel Dimension Index.

Package Type	Tape Size	A	B	C	D	G	N
SOT-23-6	8 mm	328 - 332	2.17 - 2.23	13.00 - 13.50	20.2 (min)	8	98 - 102
SO-8 / SO-8C	12 mm	330 (max)	1.5 (min)	12.80 - 13.50	20.2 (min)	12	102 (ref)
SO-16B	16 mm	330 (max)	1.5 (min)	12.80 - 13.50	20.2 (min)	16	102 (ref)
SMD-8	16 mm	330 (max)	1.5 (min)	12.80 - 13.50	20.2 (min)	16	102 (ref)
InSOP-24	24 mm	332 (max)	1.5 (min)	12.80 - 13.50	20.2 (min)	24	102 (ref)
HSOP-28	24 mm	332 (max)	1.5 (min)	12.80 - 13.50	20.2 (min)	24	102 (ref)
TO-263	24 mm	330 (max)	1.5 (min)	12.80 - 13.50	20.2 (min)	24	102 (ref)
eSOP-12B	24 mm	332 (max)	1.5 (min)	12.80 - 13.50	20.2 (min)	24.4 - 25.4	102 (ref)
eSOP-R16B	24 mm	332 (max)	1.5 (min)	12.80 - 13.50	20.2 (min)	24.4 - 25.4	102 (ref)
MinSOP-16A	24 mm	332 (max)	1.5 (min)	12.80 - 13.50	20.2 (min)	24.4 - 25.4	102 (ref)

Table 3. Reel Dimensions (in mm).

Pb-Free and RoHS Compliant Products

Power Integrations is committed to environmental, health and safety excellence and is actively complying with regulatory requirements regarding the removal of hazardous materials in manufacturing standards and processes. In response to concerns regarding the environmental impact of lead (Pb), a Pb-free solder finish is now available using 100% matte tin (Sn).

Pb-free packages offered by Power Integrations meet the requirements of the European law on the Restriction of Hazardous Substances (RoHS), which mandates the removal of lead and other hazardous substances cited in the directive. All Pb-free and RoHS compliant products have passed qualification testing for moisture sensitivity, solderability, and whisker growth. Pb-free and RoHS compliant surface mount products also comply with the joint IPC/ JEDEC industry standard on reflow solderability (J-STD-020). More information on soldering is included below.

RoHS compliant and Pb-free products are designated by an N-suffix at the end of the part number (see the Part Ordering Information section of the product family data sheets).

Green Products

Power Integrations considers GREEN a product RoHS compliant, Pb-Free and Halogen-Free. These products are designed by G-suffix at the end of the part number.

Substance	Upper Limits
Bromine	<900 ppm
Chlorine	<900 ppm
Total Halogen	<1500 ppm
Antimony Trioxide	<1000 ppm

Table 4. Halogen Free Substance Limits.

Soldering Temperature Profiles – Wave Soldering

TYPICAL FULL IMMERSION WAVE SOLDER PROFILE FOR Pb-FREE SO-8, SO-8C, SO-16B, eSOP-12B, eSOP-R16B, MinSOP-16A and InSOP-24D and 24E PACKAGES

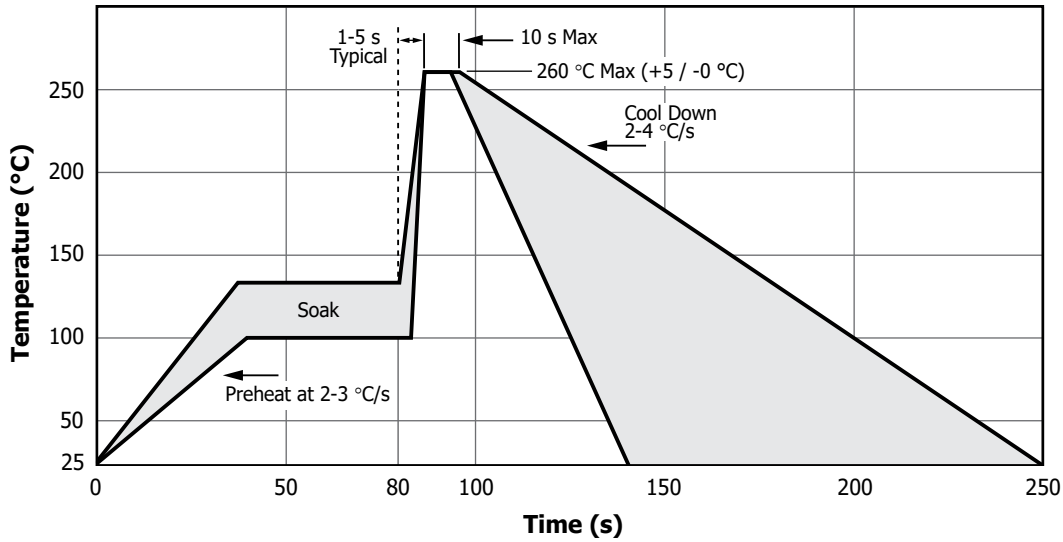

PI-5599g-102220

TYPICAL WAVE SOLDER PROFILE FOR Pb-FREE THROUGH-HOLE PACKAGES

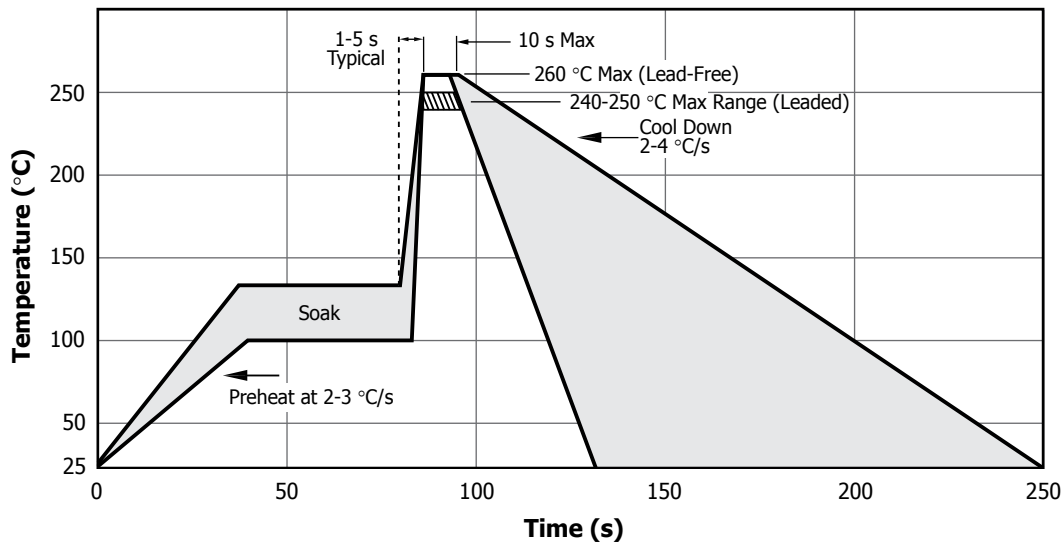

PI-3852-031215

Note 1: Pb-free packages are qualified for Sn-Pb assembly. Sn-Pb packages are not qualified for Pb-free assembly.

Wave Soldering Guidelines for InSOP and HSOP Packages

See Application Note AN-79 Wave Soldering Guidelines for InSOP and HSOP Packages.

Soldering Temperature Profiles – IR/Convection Reflow Soldering

TYPICAL IR REFLOW PROFILE FOR Sn-Pb AND Pb-FREE SURFACE MOUNT PACKAGES

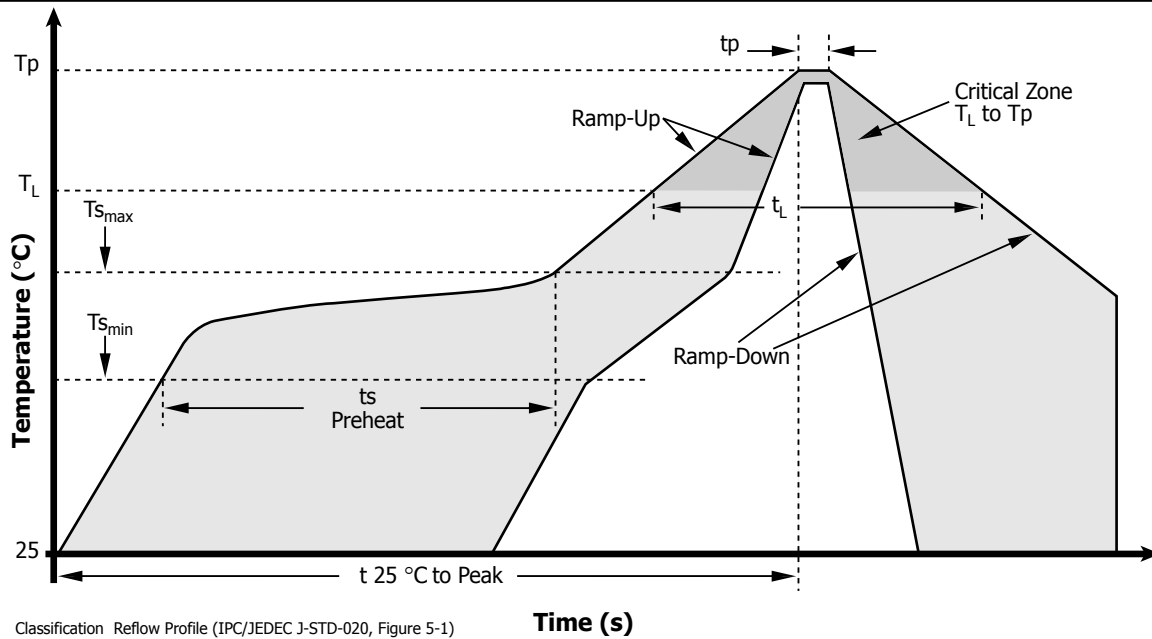

PI-3955-031215

Note 1: Pb-free packages are qualified for Sn-Pb assembly. Sn-Pb packages are not qualified for Pb-free assembly. Refer to Tables 5 and 6 for detailed reflow profile temperatures per package type.

Profile Feature	Sn-Pb Eutectic Assembly	Pb-Free Assembly
Average Ramp-Up Rate ($T_{s_{max}}$ to T_p)	3 °C/second max.	3 °C/second max.
Preheat		
± Temperature Min ($T_{s_{min}}$)	100 °C	150 °C
± Temperature Max ($T_{s_{max}}$)	150 °C	200 °C
± Time ($t_{s_{min}}$ to $t_{s_{max}}$)	60-120 seconds	60-180 seconds
Time maintained above:		
± Temperature (T_L)	183 °C	217 °C
± Time (t_L)	60-150 seconds	60-150 seconds
Peak/Classification Temperature (T_p)	See Table 6	See Table 6
Time within 5 °C of actual Peak Temperature (t_p)	10-30 seconds	20-40 seconds
Ramp-Down Rate	6 °C/second max.	6 °C/second max.
Time 25 °C to Peak Temperature	6 minutes max.	8 minutes max.

Table 5. Classification Reflow Profiles (per IPC/JEDEC J-STD-020, Table 5.2)

Note 1: All temperatures refer to topside of the package, measured on the package body surface.

Soldering Temperature Profiles – IR/Convection Reflow Soldering

Package Type	Sn-Pb Eutectic Assembly	Pb-Free Assembly
SOT-23-6	235 °C	260 °C
SO-8 / SO-8C	235 °C	260 °C
SO-16B	235 °C	260 °C
SMD-8	220 °C	250 °C*
InSOP-24 (all variants)	235 °C	260 °C
HSOP-28	235 °C	260 °C
TO-263	220 °C	245 °C
eSOP-12B	235 °C	260 °C
eSOP-R16B	235 °C	260 °C
MinSOP-16A	235 °C	260 °C

*Tolerance: Process compatibility is up to and including the stated classification temperature (this means Peak reflow temperature + 0 °C. For example, 250 + 0 °C) at the rated MSL level.

Table 6. Peak/Classification Temperature (Tp) for PI Surface Mount Packages.

Note 1: Classification temperatures are in accordance with guidelines set forth in IPC/JEDEC J-STD-020.

IR/Convection Reflow Soldering Guidelines

1. Profiles shown are typical and will therefore vary with different soldering systems.
2. Density and types of components on the board, size and type of board, solder and flux being used, substrate material being used, equipment type/model and age are factors that can influence the profile.
3. Since the melting temperature of solder is higher than the rated temperature of the device, care should be taken that the device will get as little exposure as possible at the high temperature. Not doing so increases possibility of a device failure.

4. Limit high temperature exposure only to single side or one time and mostly to the leads area only.
5. Upon completion of soldering, gradual natural cooling should be observed for a minimum of three minutes. Using forced cooling will increase temperature gradient which increases mechanical stress leading to latent failure.

PC Board Cleaning

Power Integrations does not recommend the use of "no-clean" flux.

Solder Pad Layout Design Recommendations for Wave Soldering of the InSOP Package

Power Integrations recommends the use of IR/convection reflow for surface-mount attach of the InSOP package. However, the InSOP package was designed with wave soldering in-mind in case IR/convection reflow is not available or not preferred. InSOP utilizes 0.75 mm lead pitch and narrow leads (0.25 mm width nominal) to allow adequate spacing between leads, and can be successfully attached when using wave soldering equipment with state-of-the-art features that prevent solder bridging. However, for older or less sophisticated wave soldering equipment, special PCB/footprint layout considerations are recommended as described below.

Maximum Spacing Between Solder Pads

Taking advantage of InSOP's narrow leads, solder pad-to-pad spacing can match or exceed the spacing of similar or even larger pitch and well-known wave solderable packages such as SSOP and TQFP (with 0.80 mm pitch). Of course care must be taken to ensure that the selected layout and process results in good quality solder fillets on all sides of the lead "foot", but the InSOP solder pad can be designed as narrow as 0.30 mm in width, allowing up to 0.45 mm of pad-to-pad spacing.

Layout Dimensions for Common & Finer-Pitch Wave-Solderable Leaded Packages

(All dimensions mm)	Lead Pitch (e)	Lead Width (b)	Lead Metal-to-Metal Spacing (LS)	Recommended Solder Pad Width For Wave Soldering (D)	Solder Pad Metal-to-Metal Spacing (PS)
InSOP-24	0.75	0.25	0.50	0.30 - 0.35	0.40 - 0.45
TSSOP-24	0.65	0.25	0.40	0.30	0.35
SSOP-36	0.80	0.36	0.44	0.40	0.40
TQFP-32	0.80	0.35	0.45	0.40	0.40
Standard SOIC	1.27	0.40	0.87	0.60	0.67

Table 7. Layout Dimensions for Common & Finer-Pitch Wave-Solderable Leaded Packages.

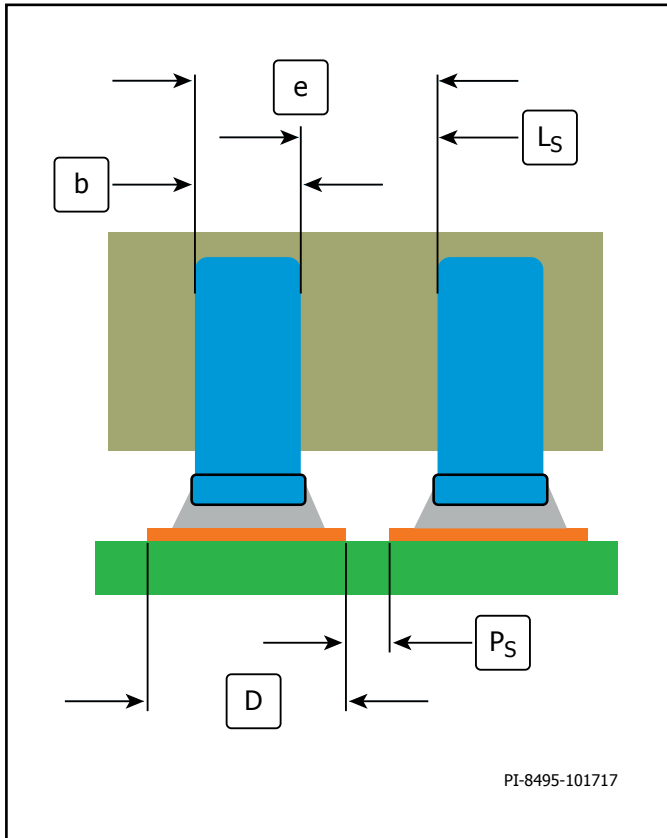

Figure 4. Solder Pad Spacing.

Solder Thieves and Orientation Through the Wave

The well-known method of designing "solder thieves" on the PCB layout has been shown to be effective in providing good wave soldering results for the InSOP package. The general concept is shown in the Figure 5, and includes large pads at the end of each row of fine-pitch solder pads combined with proper orientation of the layout through the wave. The large pads, called "solder thieves", act to draw excess solder, ensuring clean/bridge-free solder joints along the entire row of solder pads.

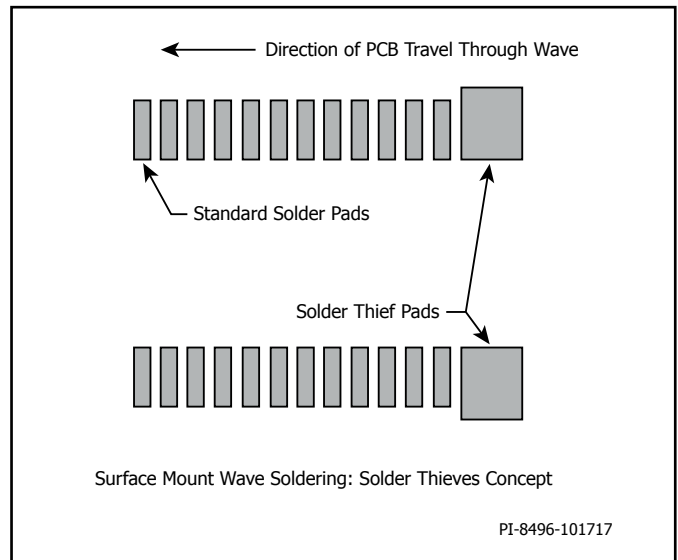

Figure 5. Solder Thieves Concept.

Package Information

Utilizing solder thieves with the InSOP package requires a couple special considerations due to the unique spacing of the leads. Depending on the flexibility for laying out the PCB and the orientation of the package, it may be possible to save some board space by combining the solder thief pad with the wide solder pad required for the wide "batwing lead" of the InSOP. The orientation of the package through the wave MUST be with the leads perpendicular to the PCB travel direction, so the two layout options for InSOP are shown below.

Exact size, location and shape of the solder thief pads may need to be modified compare to what is shown in this document depending on the type of solder wave system utilized. However, if the general principles described here are applied, the InSOP package can very successfully be used with a wave soldering process.

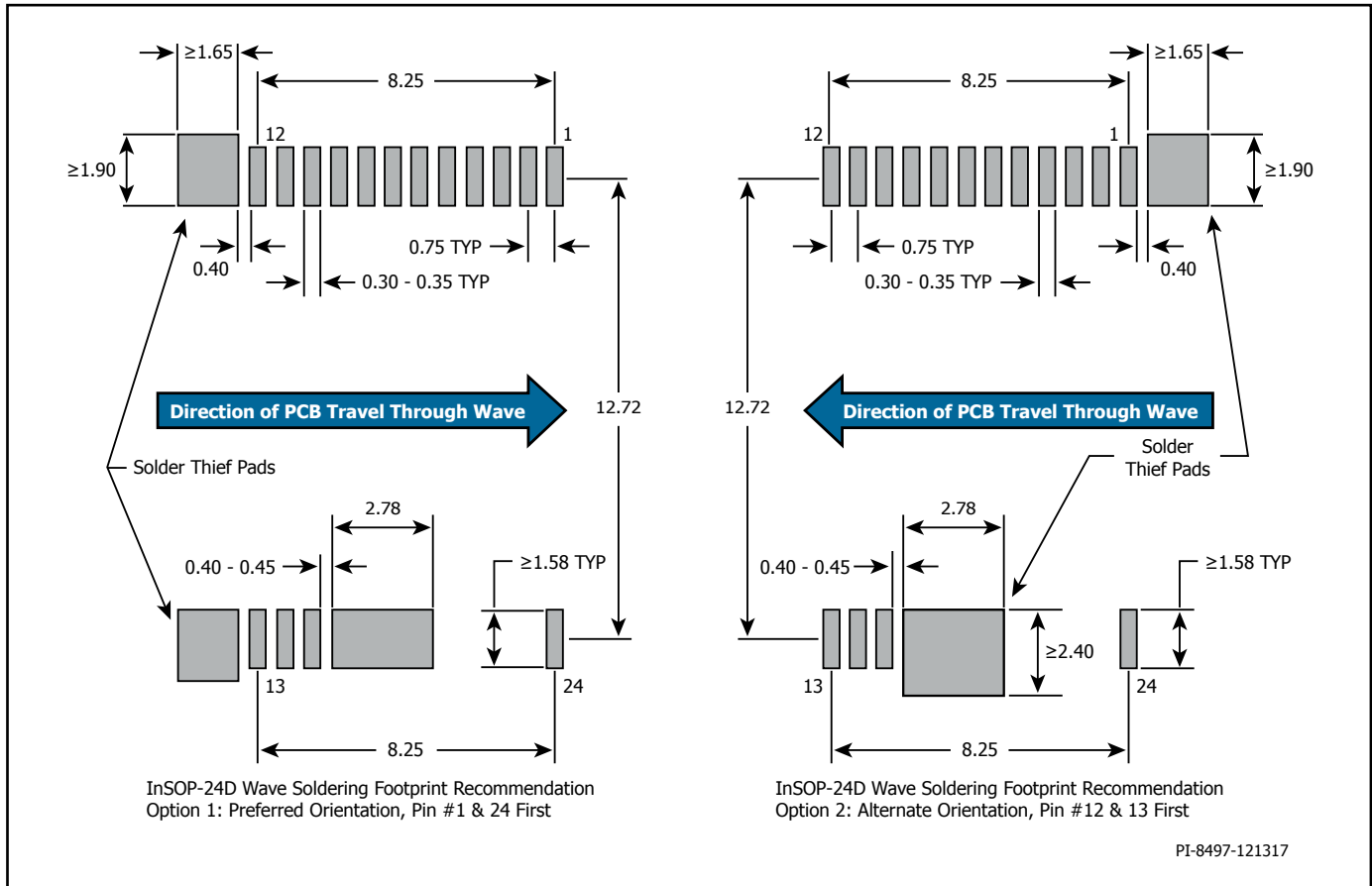

Figure 6. Wave Soldering Footprint Recommendation Preferred and Alternate Orientation.

Mounting Guidelines for TO-220 Package

Maximum Torque

The screw torque specification for the TO-220 packages used for Power Integrations products is 4 lbf × in or 0.45 N × m (4.6 kgf × cm) maximum.

Mounting Guidelines

The recommended fastener is a 6-32 screw using a rectangular washer to prevent damage to the tab. If a rectangular washer is not used, a round flat washer is required. The head of a machine screw is not flat enough to prevent damage. Without a washer, damage to the plastic case and semiconductor chip within may occur.

A smaller screw or larger heat sink hole can cause the tab to be deformed, cracking the package. Care must also be taken to prevent contact between the plastic package and the screw head or tool used to tighten it. Self-tapping screws may deform the heat sink causing poor thermal contact. Rivets should not be used under any circumstances for TO-220 packages.

The mounting surface must be flat and without burrs. Otherwise, the TO-220 tab may be bent, causing damage to the IC chip.

Finally, the IC should be mounted to the heat sink before soldering the assembly to the PCB. Soldering the IC and heat sink to the PCB and then screwing them together will put unacceptable mechanical stress on the IC package.

Package Information

Revision	Notes	Date
V	Updated wave solder profiles.	12/09
W	Page 17, per PCN 09081.	12/09
X	Added eDIP-12 package.	03/10
Y	Added SO-8 package, removed MSL information.	04/10
Z	Updated Note 2 on eSIP-7C, eSIP-7F, eDIP-12 and SO-8C.	06/10
AA	Added eSOP-12 package.	10/10
AB	Added eSIP-7G and eSIP-16B packages.	11/10
AC	Updated eSIP-16B package.	03/11
AD	Updated Table 6 with eSOP-12 package type.	03/11
AE	Added eSIP-16C package.	05/11
AF	Added eDIP-12B and eSOP-12B packages. Removed eDIP-12 and eSOP-12 packages.	10/11
AG	Added eSIP-16K L package and eSOP-12B to PI-5599.	02/12
AH	Added eSIP-16J H package.	09/12
AI	Corrected SMD-8 value in column "W" for Table 2.	02/13
AJ	Added eSIP-16D H Package, eSIP-16G L Package, eSIP-16F H Package.	06/13
AK	Updated eSIP-16F H Package.	09/13
AL	Added package identifier table.	11/13
AM	Removed IC packages – refer to data sheets.	05/14
AN	Added new Branding Style.	03/15
AO	Added eSOP-R16B package.	04/16
AP	Added SOT-23-6 package.	05/16
AQ	Noted in Table 1 that SOP8 is identical to SO-8.	08/16
AR	Corrected SOT-23-6 pin package direction in Figure 1.	04/17
AS	Added InSOP-24D package.	09/17
AT	Added wave soldering recommendations.	10/17
AU	Updated Figure 1 R package orientation per PCN-18051, and "Typical Full Immersion Wave Solder Profile" on page 4.	03/18
AV	Corrected Table 1 InSOP-24D pitch error.	04/18
AW	Added InSOP-24D to header text in top figure on page 4.	12/18
AX	Updated Solder Profile Figure PI-5599, Table 6 and removed Wave Soldering Guidelines section. Rearranged layout for pages 4, 5 and 6.	03/19
AY	Added SO-16B package information.	06/19
AZ	Added HSOP-28 package information and corrected Table 6.	09/19
BA	Added Solder Pad Layout Design Recommendations for Wave Soldering of the InSOP Package and Mounting Guidelines for TO-220 Package, pages 7 and 8.	07/20
BB	Added MinSOP-16A package information.	10/20

For the latest updates, visit our website: www.power.com

Power Integrations reserves the right to make changes to its products at any time to improve reliability or manufacturability. Power Integrations does not assume any liability arising from the use of any device or circuit described herein. POWER INTEGRATIONS MAKES NO WARRANTY HEREIN AND SPECIFICALLY DISCLAIMS ALL WARRANTIES INCLUDING, WITHOUT LIMITATION, THE IMPLIED WARRANTIES OF MERCHANTABILITY, FITNESS FOR A PARTICULAR PURPOSE, AND NON-INFRINGEMENT OF THIRD PARTY RIGHTS.

Patent Information

The products and applications illustrated herein (including transformer construction and circuits external to the products) may be covered by one or more U.S. and foreign patents, or potentially by pending U.S. and foreign patent applications assigned to Power Integrations. A complete list of Power Integrations patents may be found at www.power.com. Power Integrations grants its customers a license under certain patent rights as set forth at www.power.com/ip.htm.

Life Support Policy

POWER INTEGRATIONS PRODUCTS ARE NOT AUTHORIZED FOR USE AS CRITICAL COMPONENTS IN LIFE SUPPORT DEVICES OR SYSTEMS WITHOUT THE EXPRESS WRITTEN APPROVAL OF THE PRESIDENT OF POWER INTEGRATIONS. As used herein:

1. A Life support device or system is one which, (i) is intended for surgical implant into the body, or (ii) supports or sustains life, and (iii) whose failure to perform, when properly used in accordance with instructions for use, can be reasonably expected to result in significant injury or death to the user.
2. A critical component is any component of a life support device or system whose failure to perform can be reasonably expected to cause the failure of the life support device or system, or to affect its safety or effectiveness.

Power Integrations, the Power Integrations logo, CAPZero, ChiPhy, CHY, DPA-Switch, EcoSmart, E-Shield, eSIP, eSOP, HiperPLC, HiperPFS, HiperTFS, InnoSwitch, Innovation in Power Conversion, InSOP, LinkSwitch, LinkZero, LYTSwitch, SENZero, TinySwitch, TOPSwitch, PI, PI Expert, PowiGaN, SCALE, SCALE-1, SCALE-2, SCALE-3 and SCALE-iDriver, are trademarks of Power Integrations, Inc. Other trademarks are property of their respective companies. ©2020, Power Integrations, Inc.

Power Integrations Worldwide Sales Support Locations

World Headquarters

5245 Hellyer Avenue
San Jose, CA 95138, USA
Main: +1-408-414-9200
Customer Service:
Worldwide: +1-65-635-64480
Americas: +1-408-414-9621
e-mail: usasales@power.com

China (Shanghai)

Rm 2410, Charity Plaza, No. 88
North Caoxi Road
Shanghai, PRC 200030
Phone: +86-21-6354-6323
e-mail: chinasales@power.com

China (Shenzhen)

17/F, Hivac Building, No. 2, Keji Nan
8th Road, Nanshan District,
Shenzhen, China, 518057
Phone: +86-755-8672-8689
e-mail: chinasales@power.com

Germany (AC-DC/LED Sales)

Einsteinring 24
85609 Dornach/Aschheim
Germany
Tel: +49-89-5527-39100
e-mail: eurosales@power.com

Germany (Gate Driver Sales)

HellwegForum 3
59469 Ense
Germany
Tel: +49-2938-64-39990
e-mail: igbt-driver.sales@power.com

India

#1, 14th Main Road
Vasanthanagar
Bangalore-560052 India
Phone: +91-80-4113-8020
e-mail: indiasales@power.com

Italy

Via Milanese 20, 3rd. Fl.
20099 Sesto San Giovanni (MI) Italy
Phone: +39-024-550-8701
e-mail: eurosales@power.com

Japan

Yusen Shin-Yokohama 1-chome Bldg.
1-7-9, Shin-Yokohama, Kohoku-ku
Yokohama-shi,
Kanagawa 222-0033 Japan
Phone: +81-45-471-1021
e-mail: japansales@power.com

Korea

RM 602, 6FL
Korea City Air Terminal B/D, 159-6
Samsung-Dong, Kangnam-Gu,
Seoul, 135-728, Korea
Phone: +82-2-2016-6610
e-mail: koreasales@power.com

Singapore

51 Newton Road
#19-01/05 Goldhill Plaza
Singapore, 308900
Phone: +65-6358-2160
e-mail: singaporesales@power.com

Taiwan

5F, No. 318, Nei Hu Rd., Sec. 1
Nei Hu Dist.
Taipei 11493, Taiwan R.O.C.
Phone: +886-2-2659-4570
e-mail: taiwansales@power.com

UK

Building 5, Suite 21
The Westbrook Centre
Milton Road
Cambridge
CB4 1YG
Phone: +44 (0) 7823-557484
e-mail: eurosales@power.com
